

User instructions

Wall hung RSF gas fired condensing combination boiler

Greenstar CDi Compact ErP

For sealed central heating systems and mains fed domestic hot water



These appliances are for use with: Natural Gas or L.P.G. (Cat. II 2H 3P type C13, C33 & C53)		
	Model	GC Number
Natural Gas	28CDi Compact ErP	47-406-77
	32CDi Compact ErP	47-406-79
	36CDi Compact ErP	47-406-81
L.P.G.	28CDi Compact ErP	47-406-78
	32CDi Compact ErP	47-406-80
	36CDi Compact ErP	47-406-82

If you smell gas:

- ▶ Well away from the building: call the National Gas Emergency Service on 0800 111 999.
- ▶ L.P.G. boilers: Call the supplier's number on the side of the gas tank.



**WORCESTER**
Bosch Group

Preface

Please read these instructions carefully

These instructions are applicable to the Worcester, Bosch Group appliance model stated on the front cover only.

These instructions apply in the UK/IE only and must be followed except for any statutory obligation.

After installation please leave this User instruction Manual, Installation, Commissioning and Servicing Instructions and completed Benchmark Checklist with the user.

Dedicated to heating comfort

Thank you for purchasing a Greenstar gas-fired condensing combination appliance manufactured by Worcester, Bosch Group. The company prides itself on manufacturing appliances to the strictest quality control standards throughout every stage of production.

Worcester, Bosch group has led the field in innovative appliance design and performance for over 50 years. This heritage means all our products are of exceptional quality and proven reliability.

The Greenstar range in particular is extremely energy efficient, offering you economical running costs and value for money. It is amongst the top energy rated appliances available.

There is also the reassurance of our parts and labour guarantee - backed up by Worcester Total Cover, an optional complete maintenance scheme to keep your appliance operating at peak condition and efficiency.

Contents

1	Key to symbols and safety instructions	4	9	Tips on energy saving	19
1.1	Key to symbols	4			
1.2	Safety precautions	4			
2	General information	5	10	Environment / disposal	20
3	Controls	6	11	Your guarantee	20
3.1	Operating the boiler	8			
3.1.1	Boiler display	8			
3.1.2	Setting the boiler flow temperature for the central heating system	8			
3.1.3	Boiler frost protection	9			
3.1.4	Turning the central heating off during the summer	9			
3.1.5	Setting the flow temperature for domestic hot water system	9			
3.1.6	Domestic hot water eco and preheat modes ...	9			
3.1.7	Domestic hot water preheat mode manual activation (Eco mode off)	10			
3.1.8	Domestic hot water preheat mode timed activation, with facia timer or external timer connected (eco mode off)	10			
3.1.9	Turn off the Operation/fault diagnostic light (blue)	10			
4	System Pressure	11	12	Glossary	21
4.1	Sealed heating systems	11			
4.2	Using the Worcester integral keyed filling link	12			
5	Service clearances	13			
6	Maintaining your appliance	14			
7	Fault finding	15			
7.1	Boiler alert state	16			
7.2	Boiler reset	16			
7.3	Extreme cold weather	17			
8	Fault or breakdown	18			

1 Key to symbols and safety instructions

1.1 Key to symbols

Warnings



Safety instructions in this document are framed and identified by a warning triangle which is printed on a grey background.

The following keywords are defined and can be used in this document:

- **NOTICE** indicates a situation that could result in damage to property or equipment.
- **CAUTION** indicates a situation that could result in minor to medium injury.
- **WARNING** indicates a situation that could result in severe injury or death.
- **DANGER** indicates a situation that will result in severe injury or death.

Important information



This symbol indicates important information where there is no risk to people or property.

Additional symbols

Symbol	Meaning
1.	a numbered step in an action sequence
▶	a step in an action sequence
→	a reference to a related part in the document or to other related documents
①	a reference number to identify or refer to a part or item
•	a list entry
-	a list entry (second level)

Table 1

Examples of additional symbols used

A numbered step in an action sequence

A sequence of numbered steps or actions carried out in a specific order to complete a task.

1. First action
 2. Second action
 3. Third action
- etc.

A step in an action sequence

A sequence of defined actions or steps carried out in order to complete a task.

- ▶ Action
- ▶ Next action
- ▶ etc

A reference to a related part in the document or to other related documents.

To refer the reader to a specific figure/table/section within the manual.

→ e.g. figure 1.

A reference number to identify or refer to a part or item.

In a related figure, items or parts identified by a sequential number.

List entries, first and second levels

- A single component/item
- A component/list, made up of multiple parts/items.
 - Sub component or sublist of main component/list.
 - etc.

1.2 Safety precautions

If you smell gas:

A gas leak could potentially cause an explosion. If you smell gas, observe the following rules.

- ▶ Prevent flames or sparks:
 - Do not smoke, use a lighter or strike matches.
 - Do not operate any electrical switches or unplug any equipment.
 - Do not use the telephone or ring doorbells.
- ▶ Turn off the gas at the meter or regulator.
- ▶ Open windows and doors.
- ▶ Warn your neighbours and leave the building.
- ▶ Prevent anyone from entering the building.
- ▶ Well away from the building: call the National Gas Emergency Service on 0800 111 999.
- ▶ L.P.G. boilers: Call the supplier's number on the side of the gas tank.

Appliance operation:

This appliance can be used by children aged from 8 years and above and persons with reduced physical, sensory or mental capabilities or lack of experience and knowledge, if they have been given supervision or instruction concerning the use of the appliance, in a safe way, and understand the hazards involved.

Children shall not play with the appliance.

Cleaning and user maintenance shall not be made by children without supervision.

Combustible and corrosive materials:

Chemically aggressive substances can corrode the appliance and invalidate any guarantee.

- Do not store or use any combustible materials (paper, thinners, paints, propellants, cleaning agents etc.) inside the cupboard containing the appliance or within the vicinity of the appliance.

Fittings and modifications:

Only a competent engineer can remove the appliance case and carry out any work, in accordance with the Gas Safety (Installation and Use) Regulations.

- Do not remove the appliance case.

Any misuse or unauthorised modifications to the appliance, flue or associated accessories and heating system will invalidate the guarantee.

- Do not modify the appliance or flue system in any way.

Worcester, Bosch Group accepts no liability arising from any such actions. This does not affect your statutory rights.

Cleaning the appliance case:

Use a damp, soft cloth to clean the outer painted metal case of the appliance, do not use chemicals or abrasive materials.

2 General information

2.1 Energy efficiency

Energy efficiency information is given in the Installation, Commissioning and Servicing Instructions supplied with the appliance.

2.2 Servicing



Ensure that the service engineer completes the Service Record in the Benchmark Checklist after each service. The Benchmark Checklist and service interval record can be found at the rear of the Installation, Commissioning and Servicing Instructions.

- The appliance must be serviced regularly by a competent, qualified person, such as a Worcester service engineer or other Gas Safe registered engineer.
- Always use original spares, to help maintain the efficiency, safety and reliability of the appliance and have the Service Record completed in the Benchmark Checklist.

The completed Benchmark Checklist will be required in the event of any guarantee work and may be required by the local Building Control Inspector.

2.3 Benchmark standard



The Benchmark initiative is a code of practice to encourage the correct installation, commissioning and servicing of domestic central heating appliances and system equipment.

A “checklist” is dispatched with every appliance and can be found towards the back of the Installation, Commissioning and Servicing Instructions. This is a vital document that needs to be completed by the installer at the time of installation. It confirms that the appliance has been installed and commissioned according to the manufacturer's instructions.

The service record provides space for the recording of regular servicing of the appliance/heating system and this can become a valuable document when, for example, you wish to sell the property. The service record will show a potential purchaser that the heating system has received regular professional maintenance and servicing during its lifetime.

The Benchmark initiative aims to:

- Raise standards among professional installers
- Build and maintain high safety standards in the industry
- Improve customer satisfaction levels
- Make a contribution to the nation's commitment to climate change

2.4 User caution

- It is forbidden for any interference with the appliance other than those actions allowed in this document.



CAUTION: Incorrect use

- ▶ Any incorrect use can result in danger to the householder.

3 Controls

► To gain access to the boiler controls pull the flap down using the curved flap handle.

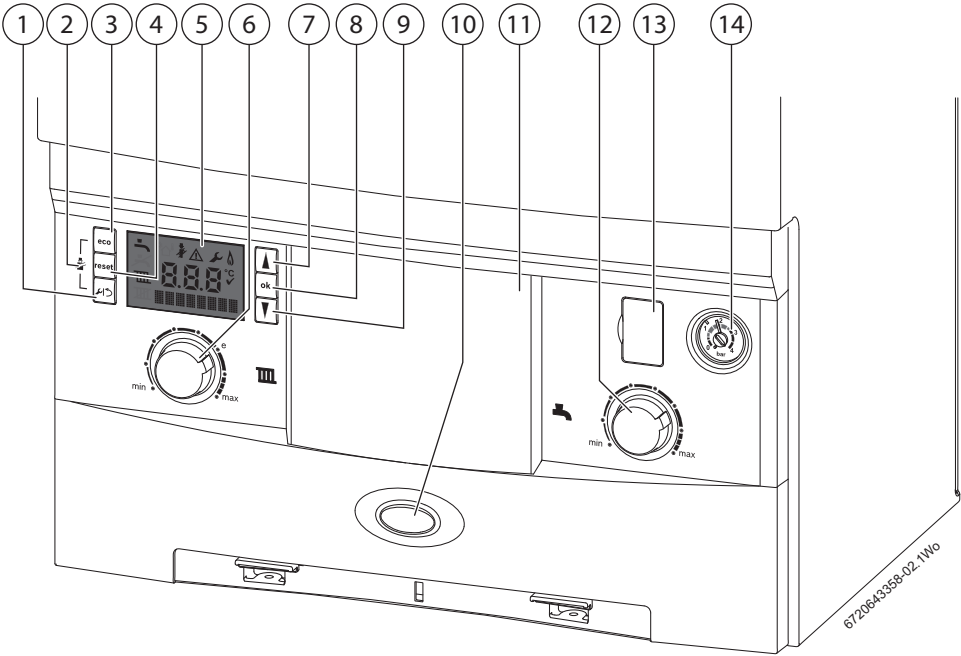
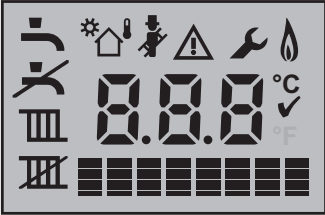













Fig. 1 Basic boiler controls

Boiler Controls	1	Service menu/back button	9	Scroll down button
	2	Service engineer symbol = boiler is set to maximum or minimum output for service	10	The blue light is ON when the boiler is in an operational mode. It will also flash to indicate a fault.
	3	Eco button	11	Position for optional programmer
	4	Reset button	12	Hot water temperature control
	5	Boiler display	13	Diagnostic port*
	6	Central heating temperature control	14	Central heating system pressure gauge
	7	Scroll up button		
	8	OK - Select/confirmation button		

* for Worcester service engineer use only

Display symbols

SCREEN DISPLAY	BRIEF DESCRIPTION	EXPLANATION
	All possible screen symbols	This screen is displayed briefly during boiler start up and shows all the symbols that could be displayed on the screen.
	Numerical display	Displays a temperature setting or boiler status code.
	Text display	Display PreHeat or Eco, or the Alert code
	Hot water	Displays this symbol during a DHW demand.
	Central Heating	Displays this symbol during central heating demand.
	Service engineer mode	Displays during service when the boiler is set to maximum or minimum output.
	Alert	Displays along with the boiler status code and diagnostic code during a fault condition.
	Service mode	Displays when a qualified service engineer is in the service menus.
	Burner on	The boiler is in operation and the flame is alight.
	Centigrade indication	Displays next to the temperature reading.
	Confirmation	This symbol confirms a setting change.
	Maintenance codes	A code displayed with an H and a number relates to a maintenance issue. This is not a boiler fault but an indication that something will need attention concerning the boiler. The example shown is H13 Service interval reached, the boiler requires servicing. Call your installer or Worcester Bosch Group to organise a service visit.

3.1 Operating the boiler

3.1.1 Boiler display

This is typical of the display when the boiler is not supplying a central heating or hot water demand. The display will not be backlit and the internal temperature of the boiler is displayed.

When heat is demanded and the boiler fires up, the flame symbol will be displayed.

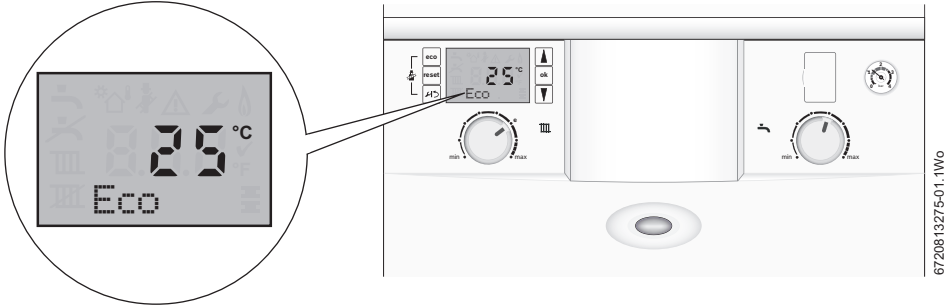

3.1.2 Setting the boiler flow temperature for the central heating system

1. Turn the central heating temperature control knob to the desired flow temperature between 30 and 82°C, this will be indicated on the digital display. This is not the room temperature but the flow temperature through the radiators. The "e" point provides guidance for the maximum temperature setting for optimum energy efficiency.
2. The radiator symbol will be displayed to confirm that the a central heating setting is being changed.
3. The value is displayed during this process, press **ok** to exit or after five seconds of inactivity the boiler display will return to the default screen.

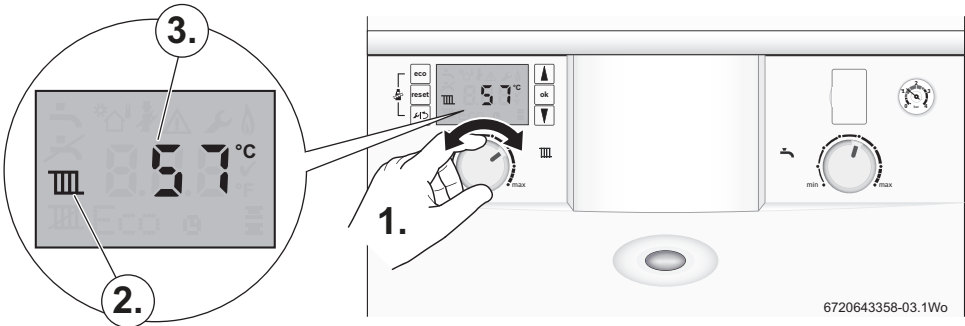

- Comfort levels within rooms should be controlled by your thermostatic radiator valves and/or room thermostat.

3.1.3 Boiler frost protection

If you are leaving your property unoccupied during cold weather, please leave your programmer on constant and your room thermostat set to 15°C.

- ▶ If the temperature within the boiler falls below 8°C the pump will run to circulate water and prevent the system freezing.
 - If the temperature does not rise to 9°C within 30 minutes of the pump operating, the boiler will fire up to provide heat to bring the temperature up.
- ▶ If the temperature within the boiler falls below 5°C the boiler will fire immediately, bringing the boiler temperature up to 12°C to avoid the possibility of the system freezing.
- ▶ This process will be repeated until such time that the boiler temperature does not drop below 5°C.

3.1.4 Turning the central heating off during the summer



Do not switch the appliance off at the mains fused spur.

- ▶ Turn your programmer/timer to the off position.
- ▶ Please refer to the programmer/timer manufacturer's instructions.

3.1.5 Setting the flow temperature for domestic hot water system

1. Turn the hot water temperature control knob to the desired level between 40 and 60°C, this will be shown on the digital display.

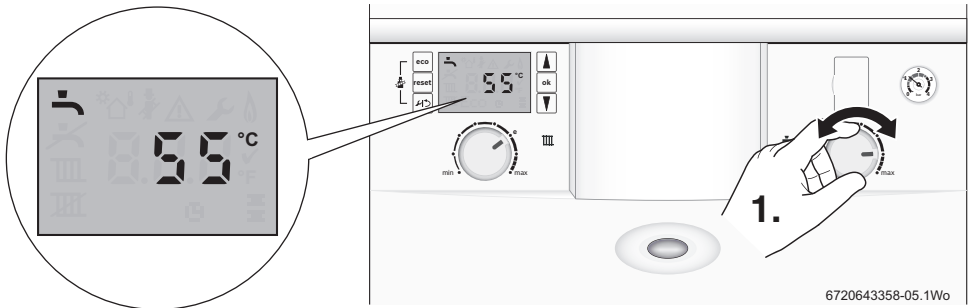

The value is displayed during this process, press to exit or after five seconds of inactivity the boiler display will return to the default screen.



3.1.6 Domestic hot water eco and preheat modes

- Eco mode is an energy saving feature which disables the Preheat function. Eco is enabled by default, during the initial appliance start up and Eco is displayed.
- Preheat mode, the hot water heat exchanger is kept pre-heated to reduce the time taken to deliver hot water at the tap.

In the Preheat mode, if there has been no demand for hot water for 24 hours the appliance will save energy by suspending Preheat until there is a demand for hot water. At this time Preheat mode is re-activated. It is advised to use a twin channel programmer to time the Preheat function and switch it off when it is not needed.

3.1.7 Domestic hot water preheat mode manual activation (Eco mode off)

Eco mode is enabled by default and the PreHeat can be enabled.

1. Press and hold  for at least four seconds to enter the PreHeat mode, when preheat mode is active, "PreHeat" will be displayed.
- To exit PreHeat mode and return to PreHeat, press and hold  for at least four seconds, PreHeat will be displayed.

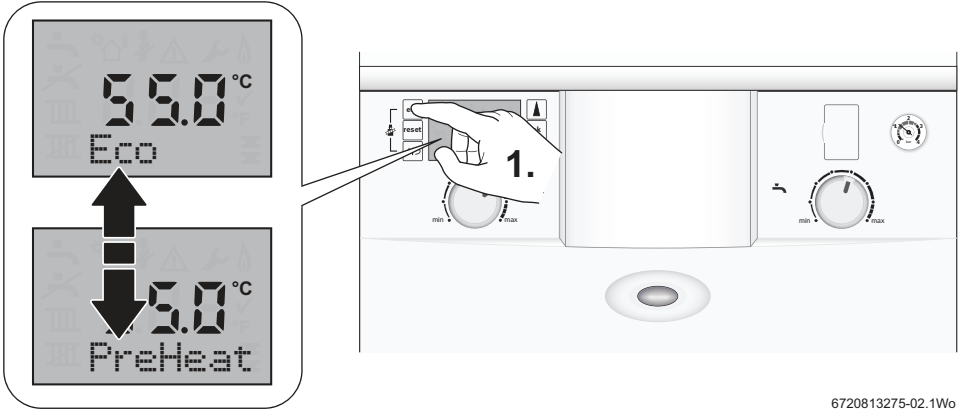

6720813275-02.1Wo

3.1.8 Domestic hot water preheat mode timed activation, with fascia timer or external timer connected (eco mode off)

When a twin channel programmer is fitted/connected, the Preheat/Eco option can be selected via the programmer.

- Programmer hot water channel ON periods:
 - "PreHeat" mode is active and indicated on the appliance display.
- Programmer hot water channel OFF periods:
 - "Eco" mode active and indicated on the appliance display.

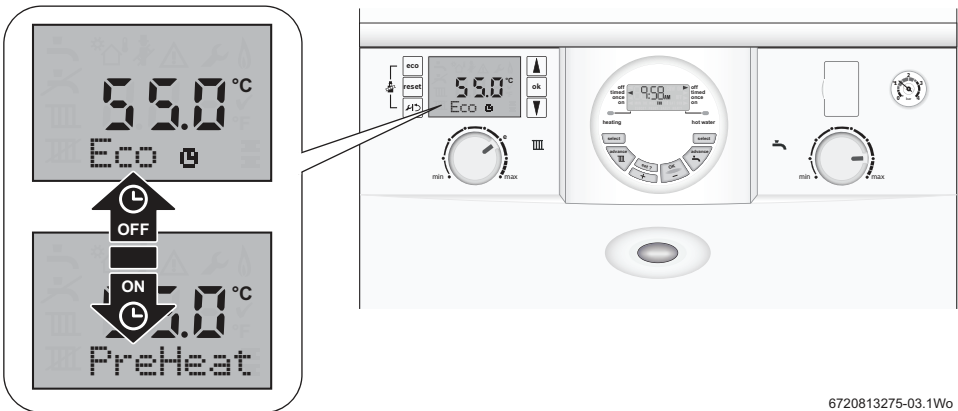

6720813275-03.1Wo

3.1.9 Turn off the Operation/fault diagnostic light (blue)

You may choose to deactivate the operation/fault diagnostic light. Please ask your installer to set-up this feature.

The light will still flash to alert you to a possible fault, but will not activate during a heat requirement demand for heating or hot water.

4 System Pressure

4.1 Sealed heating systems

This appliance is fitted to a sealed heating system which is pre-pressurised. Your installer will advise you of the minimum and maximum pressure indicated on the pressure gauge.

- ▶ Check regularly that the pressure is maintained.
- ▶ If the pressure gauge reads less than 1 bar then the system requires re-charging.
- ▶ Contact your installer or maintenance engineer if a permanent significant decrease or increase in pressure is indicated on the pressure gauge.

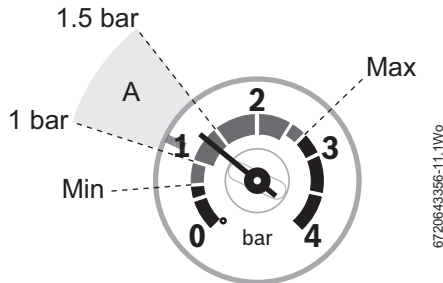

Fig. 2 Optimum system pressure when your boiler is cold (area A)

- ▶ Use the Worcester integral filling link supplied with the boiler to re-pressurise your boiler, refer to the following section 4.2.



NOTICE: To comply with the Water Authority regulations you must remove the “filling key” or disconnect the external filling loop after re-pressurisation.

4.2 Using the Worcester integral keyed filling link

Locate the filling key firmly into the body of the filling link, ensuring the arrow on the key shaft lines up with the open padlock symbol.

1. Push the filling key firmly into the body of the filling link, ensuring the arrow on the key shaft lines up with the open padlock symbol.
2. Turn the filling key to the right, to the stop, ensure the key is locked and that it cannot still turn. The arrow should line up with the closed padlock symbol. This bridges the gap between the two sections of the filling loop.
3. Turn the white knob to the left, this will allow water to fill the system.
4. When the pressure, shown on the appliance facia pressure gauge, reaches between the 1 and 1.5 bar marks (zone A), turn the white knob to the right to close the valve. Do not overtighten.
5. Turn the filling key to the left, to the stop, so that the arrow lines up with the open padlock symbol and pull the key straight down to remove. Please remember to store the key in the bottom panel.

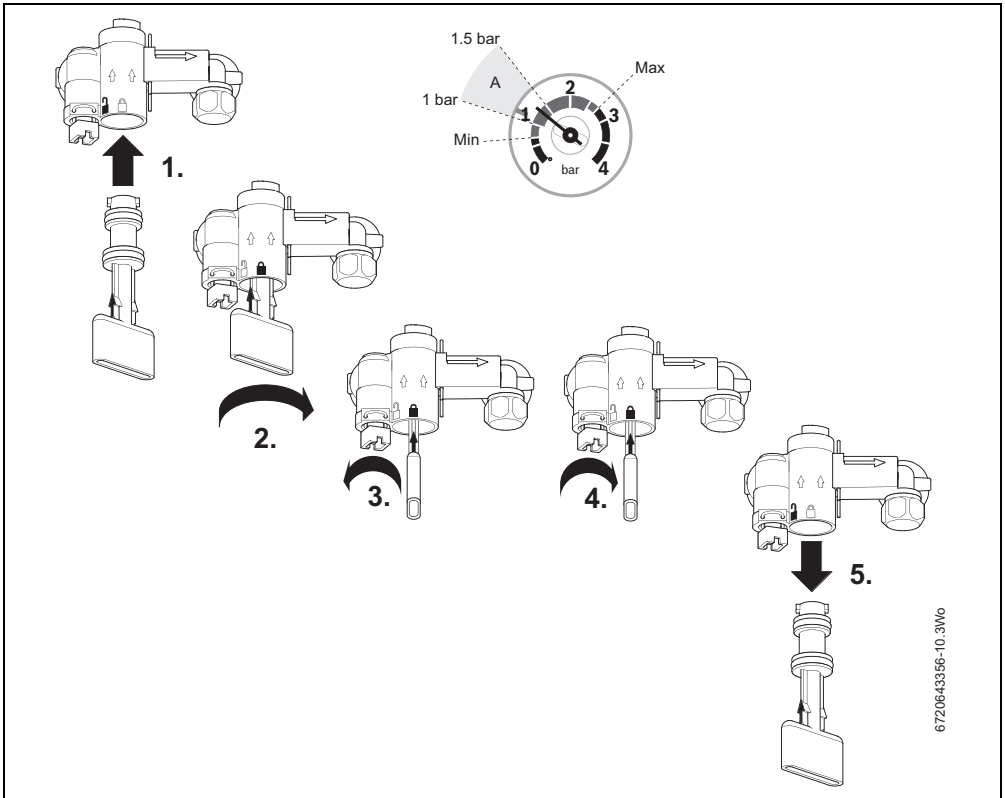

Fig. 3 Keyed filling link



If the pressure gauge reads more than 1.5 bar as a result of over filling, bleed one radiator until the pressure gauge returns to between 1 and 1.5 bar.

5 Service clearances

Your installer will have provided adequate space around the boiler for safety and servicing access.



CAUTION: Restricted space.
The boiler may overheat.

- ▶ Do not restrict this space with the addition of cupboards, shelves etc. next to the boiler.



NOTICE: Combustible and corrosive materials:

Chemically aggressive substances can corrode the appliance and invalidate any guarantee.

- ▶ Do not store or use any combustible materials (paper, thinners, paints, propellants, cleaning agents etc.) inside the cupboard containing the appliance or within the vicinity of the appliance.

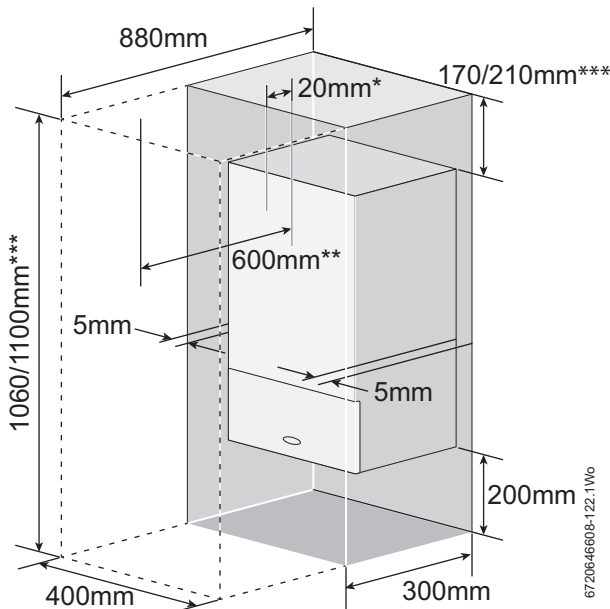

Fig. 4 Service clearances

[*] Minimum clearances to removable door

[**] Minimum clearances required for servicing

[***] Height for either 60/100 flue or 80/125 flue

6 Maintaining your appliance

Your new gas-fired appliance represents a long term investment in a reliable, high quality product.

Wipe the appliance casing with a soft clean cloth. Please do not use chemical cleaning products which may damage the paint finish.

In order to realise its maximum working life, and to ensure it continues to operate at peak efficiency and performance, it is essential that your appliance receives regular servicing and maintenance checks from a competent person beyond the initial guarantee period.

If your Greenstar gas-fired appliance should fail to operate correctly or requires servicing, please contact the Worcester, Bosch Group Appointments Team (see rear cover for details).

Details of the appliance including the Gas Council number can be found on the front cover of these User Instructions and on the appliance identification label on the appliance fascia.

The Gas Council number is also listed on the front cover of your Installation, Commissioning and Servicing Instructions.

7 Fault finding

In the event that the appliance stops functioning or does not perform as expected, please see table below. These problems are some of the most common causes. Should the problem persist or if other fault codes are displayed, then it will be necessary to contact Worcester, Bosch Group.

This table gives information on basic operating system problems.

Problem	Cause	Remedy
EA fault code flashing on display	No gas supply/low gas supply pressure	▶ Contact your gas supplier.
	Condensate outlet blocked	▶ If it is safe to do so, check your condensate pipe outlet for blockages, such as ice or foreign objects.
	Flue blocked	▶ If it is safe to do so, check your flue outlet for damage or blockages.
Desired room temperature is not reached	Thermostatic radiator valve(s) set too low	▶ Increase thermostatic radiator valve setting(s).
	Temperature control for central heating flow on appliance set too low	▶ Increase central heating flow temperature control setting
	Low temperature setting on the room thermostat	▶ Increase setting on the room thermostat.
	Air trapped in heating system	▶ Bleed radiators and re-pressurise the heating system
	Low system water pressure	▶ Re-pressurise the system, refer to page 12
Desired room temperature too high	Thermostatic radiator valves are set to high	▶ Turn down thermostatic radiator valves.
	Room thermostat is set too high	▶ Turn down room thermostat.
Radiators are too hot	Temperature control on appliance set too high	▶ Reduce central heating temperature by turning down the Central Heating control on appliance. Note: This could prevent your property reaching the desired temperature during cold weather periods.
Heating stays on for too long	Clock is incorrectly set	▶ Check clock setting and adjust
No blue Operation/Fault Indicator demand	Momentary power failure	▶ Disconnect boiler supply, wait a few seconds then reconnect.
	Heat requirement demand operation on light has been deactivated	▶ Ask your installer to reset the blue light
Hot water temperature too low	Temperature set too low on boiler controls	▶ Check setting and adjust
	Water flow at tap too high	▶ Reduce flow rate at tap
	Air trapped in heating system	▶ Bleed radiators and re-pressurise the heating system
	Low system water pressure	▶ Re-pressurise the system, refer to page 12
Hot water temperature too high	Temperature set too high on boiler controls	▶ Check setting and adjust
	Water flow at tap too low	▶ Increase flow rate at tap

Table 2 Fault finding

7.1 Boiler alert state

In the event of an alert, a fault code and an alert symbol  will be displayed on the boiler display, and the blue operation/fault light will flash, e.g. EA, reset your boiler.

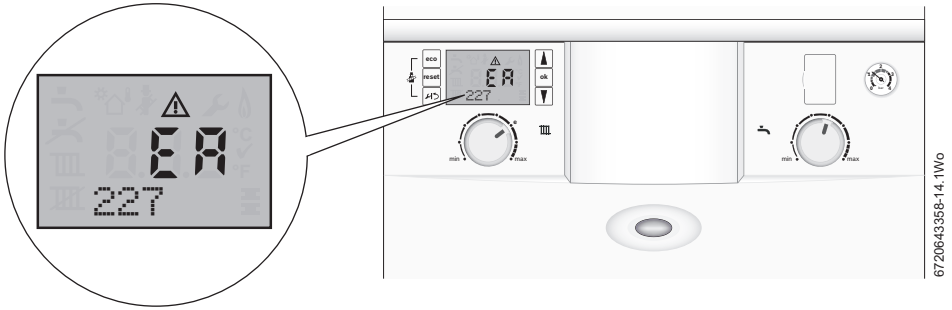

7.2 Boiler reset

1. To reset the boiler, press .

2. "Reset" and  are briefly displayed.

- ▶ If the reset was successful the boiler will return to normal operation.
- ▶ If the reset was not successful then the alert code will be displayed again, and the blue operation/fault light will continue to flash.

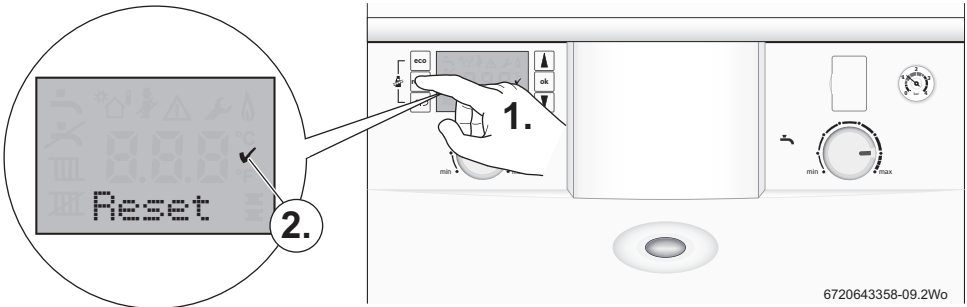

Due to the internal safety systems of your Greenstar CDi Compact^{EP} boiler, some codes cannot be cleared by a simple reset. Please contact Worcester, Bosch Group for further assistance.

When calling Worcester, Bosch Group about a fault, it will be useful to quote the alert code and three digit number under the alert code, e.g. EA and 227. If there is a fault that cannot be reset by you, the user, then a service engineer visit will be necessary.

7.3 Extreme cold weather

In certain instances where the condensate pipe work is run externally or in an unheated area, such as a garage, the condensate pipe work can be at risk of freezing, even if well insulated.

A frozen/blocked condensate pipe will cause the boiler to shut down. Worcester, Bosch Group have available on our website helpful videos in the Customer service section.



WARNING: Falling hazard!

Failure to follow this guidance may result in personal injury.

- ▶ Only attempt to thaw a condensate pipe that is at ground level and easily accessible.
- ▶ Never attempt to thaw a condensate pipe that is at height.



CAUTION: Pipe damage

- ▶ **DO NOT** use boiling water to thaw the condensate pipe!

If the condensate pipe has frozen:

- ▶ Locate the blockage.
It is likely that the pipe is frozen at the most exposed point outside the building or where there is an obstruction to flow. This could be the open end of the pipe, at a bend or elbow, or where there is a sag in the pipe in which condensate can collect. The location of the blockage should be identified as closely as possible before taking further action.
- ▶ Thaw the frozen pipe.
The pipe can be thawed by applying a hot water bottle, a microwaveable heating pack (the sort used for muscular aches and pains) or a cloth soaked in hot water to the exterior of the pipe, close to the point of blockage. Hot water, but not boiling, can also be poured onto the pipe from a watering can or similar container. Care must be taken at pedestrian areas where this water may freeze and create a slip hazard.
- ▶ Worcester, Bosch Group have available on our website helpful videos in the Customer service section to aid in thawing a frozen pipe.
- ▶ Once the pipe has been thawed the boiler must be reset, press the reset button for five seconds and wait two to three minutes for the boiler to restart.
- ▶ If the boiler does not restart, contact Worcester, Bosch Group Appointments Team on: 0330 123 9339.
- ▶ Contact your installer in order to find a permanent solution to the problem.

8 Fault or breakdown

This boiler is supported in the UK and Eire by Worcester, Bosch Group.

Specialist service engineers are available to attend a breakdown occurring on this boiler.



Invoices for attendance and repair work carried out on this boiler by any third party will not be accepted.

-
- No charge will be made for parts and/or labour providing:
A boiler fault is found and the boiler is within the guarantee period. Reasonable evidence of this must be supplied on request. i.e. the Benchmark Checklist.
 - A call-out charge will be made where:
 - The boiler is outside the guarantee period.
 - Evidence cannot be provided that the first year service inspection has been carried out (i.e. an entry in the Benchmark Checklist).
 - Our Field Service Engineer finds no fault with the boiler.
 - The cause of breakdown is misuse or with other parts of your plumbing/heating system, or with equipment not supplied by Worcester, Bosch Group.

Technical support



No boiler fault is found on over 30% of all service calls.

In the case of a suspected fault, refer to the fault finding section of this guide.

In the event of a boiler fault or breakdown please contact Worcester, Bosch Group appointments team on 0330 123 9339. Your advisor will arrange for an engineer to call with the minimum of delay; under normal circumstances this will be from 1 - 3 working days (excluding weekends and bank holidays) for priority breakdown situations (no hot water and/or heating).

9 Tips on energy saving

Heating economically

The appliance provides a high level of comfort whilst keeping gas consumption low and so minimising the environmental impact. The gas supply to the appliance's burner is regulated according to the demand for heat. The appliance operates with a low flame if the demand for heat reduces. The technical term for this process is modulating control.

Modulating control reduces temperature fluctuations and provides an even distribution of heat throughout the home. This means that the appliance may stay on for relatively long periods of time but will use less gas than a appliance that continually switches on and off.

Central heating systems with room thermostat/thermostatic radiator valves

With modern heating systems designed around a 20 °C heat loss across the system, the optimum setting for a condensing appliance as described on section 3.1.2, Setting the boiler flow temperature for the central heating system. The system must be balanced correctly and the radiators may need upgrading.

The temperature of each room can be set individually (except primary room with the room thermostat) using the thermostatic radiator valves.

Room thermostats

Reducing the setting of the room thermostat by 1 °C can reduce fuel consumption by up to 10%.

New control systems

Upgrade your heating control system if necessary with the latest equipment available.

Roof insulation

Around 30% of the heat loss from a property is through the roof. Replace any old insulation with new insulation, preferably of around 200mm thickness or more.

Window frames

Single glazed windows, particularly those with steel frames, can lose a great deal of heat. Consideration should be given to replacement with PVCu or wooden framed double glazed units.

Radiators

If a radiator is sited underneath a window, its performance will be affected if the curtains are allowed to drape over the radiator. Shelves fitted above or in front of the radiator should also be avoided.

It is advisable to manually adjust all thermostatic radiator valves every 2 - 3 months to prevent them sticking. Ensure radiator valves are correctly set and not damaged.

Draughts

Try to ensure that draughts around doors, windows, letter boxes and keyholes etc. are reduced by using a suitable draught excluder.

**WARNING:** Air vents

- ▶ Do not block or seal any air vents that are installed to ensure that the central heating appliance operates safely.

Curtains

Lined curtains, or heavier full length curtains can provide excellent insulation. However, always ensure that the curtains do not drape over radiators.

10 Environment / disposal

Environmental protection is a fundamental corporate strategy of the Bosch Group.

The quality of our products, their economy and environmental safety are all of equal importance to us and all environmental protection legislation and regulations are strictly observed.

We use the best possible technology and materials for protecting the environment taking account of economic considerations.

Packaging

We participate in the recycling programmes of the countries in which our products are sold to ensure optimum recycling.

All of our packaging materials are environmentally compatible and can be recycled.



USED APPLIANCES

- ▶ All Greenstar gas boilers are 100% recyclable.

The various assemblies can be easily dismantled and synthetic materials are marked accordingly. Assemblies can therefore be sorted by composition and passed on for recycling.

11 Your guarantee

This boiler has a guarantee against faulty materials or workmanship for a period from the date of installation subject to the following terms and conditions:

- During the period of this guarantee any components of the boiler which are proven to be faulty or defective in manufacture will be exchanged or repaired free of charge by Bosch Thermotechnology Ltd.
- The householder may be asked to prove the date of installation, that the boiler was correctly commissioned and, where appropriate, the first year's service has been carried out to the satisfaction of Bosch Thermotechnology Ltd., when requested. These should be documented as a part of the Benchmark Checklist.
- The boiler has been used only for the normal domestic purposes for which it was designed.

This guarantee does not affect your statutory rights.

Guarantee registration

Your Greenstar boiler carries a guarantee against faulty material or manufacturer subject to Terms and Conditions.

To read the full Terms & Conditions please visit us on-line at www.worcester-bosch.co.uk/guarantee. The Guarantee Registration form is available on this same page and can be completed and submitted electronically.

Alternatively, please telephone one of our Guarantee Registration advisors on 0330 123 2552.

Your statutory rights are not affected by the manufacturers guarantee.

For your own record:

Please ensure that the Benchmark Checklist has been completed by your installer or service engineer.

Model	
Serial No. ¹⁾	
Type/size	
Date of installation	
Name of Installer	
Telephone number of Installer	

Table 3

- 1) See boiler identification label on boiler fascia or Benchmark Checklist in the back of the Installation, Commissioning & Servicing Instructions.

12 Glossary

Central heating systems

All radiators must be heated at an even rate. If the top of a radiator is at a lower temperature than the bottom then it should be bled by releasing air through the bleed screw at the top of the radiator.

Ask your installer to show you how this is done.

This boiler is fitted to a sealed system. Should water leaks be found or if excessive bleeding is required, then a service engineer must be contacted to inspect the installation and rectify any fault.

Only additives that are compatible with aluminium may be used in the system. Any incompatible additive used will invalidate the guarantee.

Plumbing and condensate drain

This is a condensing boiler and the flue terminal will, at times give out a plume of water vapour. This is quite normal.

The boiler produces condensate which is discharged regularly by a syphon within the boiler via a plastic pipe to a drain. This pipe must not be blocked or altered in any way.

Room thermostat / programmer

A room thermostat / programmer must be fitted to control the central heating. This controls the times and temperatures of the central heating, preventing the boiler from firing unnecessarily. Refer to the instructions supplied with the thermostat and programmer for further information.

Thermostatic radiator valves

Thermostatic radiator valves must be fitted in sleeping accommodation. It is recommended that this type of valve is fitted to all but one of the radiators. The remaining radiator, where the room thermostat is located, must be uncontrolled and left open.

Pump over run function

After the boiler has finished a demand for central heating or hot water, the pump may continue to run for a short while to dissipate the heat from within the boiler.

Pump anti-seizure

If there has been no heating demand for 24 hours, the boiler will run the system pump for a few seconds to reduce the possibility of pump seizure during long periods of inactivity.

Notes

Notes

Worcester, Bosch Group
Cotswold Way, Warndon, Worcester WR4 9SW.
Tel. 0330 123 9559
Worcester, Bosch Group is a brand name of
Bosch Thermotechnology Ltd.

worcester-bosch.co.uk

6 720 813 277 (2014/09)

WORCESTER, BOSCH GROUP:

TECHNICAL SUPPORT:	0330 123 3366
APPOINTMENTS:	0330 123 9339
SPARES:	0330 123 9779
LITERATURE:	0330 123 9119
TRAINING:	0330 123 0166
SALES:	0330 123 9669

