

Mains Powered

# Ei3024 / 3016 / 3014

## Alarms

Instruction Manual

Read and retain carefully for as long as the product is being used. It contains vital information on the operation and installation of your Alarm. The leaflet should be regarded as part of the product.

If you are just installing the unit, the leaflet **MUST** be given to the householder. The leaflet is to be given to any subsequent user.



## Contents

<b>Installer Guide</b>	<b>4</b>
<b>1. Introduction</b>	<b>4</b>
1.1 Overview	6
1.2 Technical Specifications	8
<b>2. Installation</b>	<b>10</b>
2.1 Important Safety Instructions	11
2.2 Where to locate the Alarm?	12
2.3 Which Alarm in what room?	16
2.4 Where in the room?	18
2.5 Locations to avoid	19
2.6 Mounting and wiring	21
2.7 Interconnecting Alarms	25
2.8 Removing the Alarm	27

<b>User Guide</b>	<b>28</b>
<b>3. Testing</b>	<b>28</b>
3.1 Testing and maintaining your Alarm	29
3.2 Cleaning your Alarm	31
<b>4. What to do in case of alarm</b>	<b>33</b>
<b>5. Troubleshooting and Indicator summary tables</b>	<b>35</b>
<b>6. Important safeguards</b>	<b>43</b>
<b>7. Service and Guarantee</b>	<b>46</b>
7.1 Getting your Alarm serviced	47
7.2 Guarantee	47

# Installer Guide

# 1

## Introduction

The Ei3024 is a Multi-Sensor Fire Alarm with heat enhanced optical smoke sensor and automatic dust compensation, delivering a faster response to a wider range of fires. It detects both smoke and heat from a fire and is ideal for hallway, landing, living room and bedroom areas.

The Ei3016 is an Optical Smoke Alarm, with a proven optical sensor and automatic dust compensation delivering a fast response to smouldering fires. It is ideal for hallway, landing and living room areas.

The Ei3014 is a Heat Alarm with a Class A1 heat detection sensor. It can only be used as part of a fire detection system, i.e. interconnected with Ei Electronics mains powered Multi-Sensor Fire or Smoke Alarms. It is ideal for kitchens, garages, boiler houses and other areas where there are normally high levels of fumes, smoke or dust i.e. places where Smoke Alarms cannot be installed without the risk of excessive nuisance alarms.

Up to 12 Alarms can be interconnected so that if one senses fire, all Alarms sound. It can be a hardwired interconnection, a wireless interconnection or a mixture of both (for the wireless option an Ei3000MRF SmartLINK module needs to be added to each Alarm – sold separately).

The Ei3000 series is supplied with a mounting plate that allows very quick and simple installation of the Alarm. The mains and battery power is automatically connected as the Alarm slides onto the mounting plate. Each Alarm comes with built-in rechargeable backup batteries to power the Alarm in the event of a mains failure.

### **AudioLINK**

The Ei3000 series Alarms are AudioLINK enabled. This feature allows the user to download information from the Alarm through the use of a mobile App. For more information on using this feature, please refer to the relevant section on [www.eielectronics.com](http://www.eielectronics.com) or [www.aico.co.uk](http://www.aico.co.uk).

## 1.1 Overview

### Ei3024 Multi-Sensor Fire Alarm

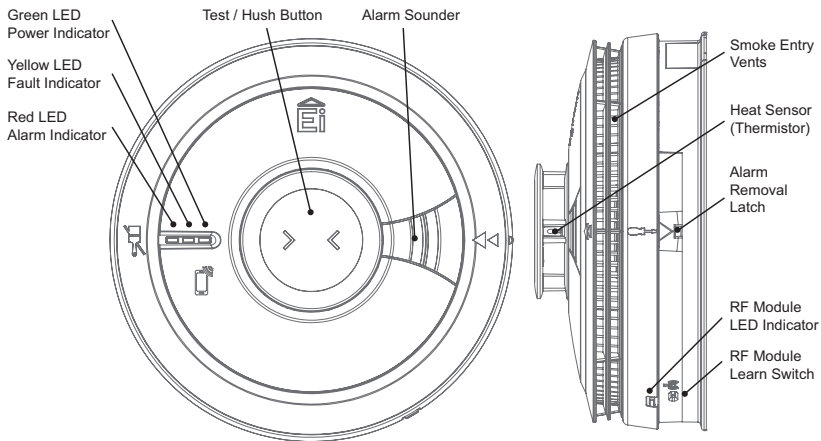

### Ei3016 Optical Alarm

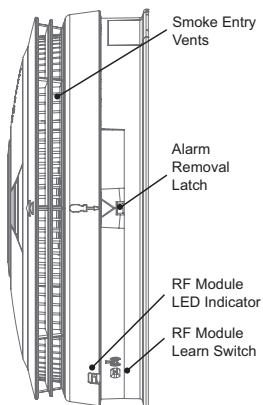

### Ei3014 Heat Alarm

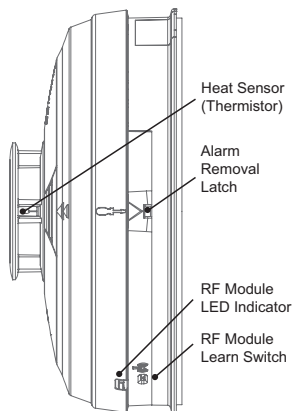

## 1.2 Technical Specifications

<b>Optical Sensor</b>	Optical (Ei3024 and Ei3016)
<b>Heat Sensor</b>	Thermistor Class A1 Detection (Ei3014 and Ei3024)
<b>Power Supply</b>	100-250V AC, 50Hz, 0.25W
<b>Battery Backup</b>	Built-in 10-year rechargeable Vanadium Pentoxide Lithium cells. Fully charged, the battery will provide up to 6 months (without module fitted) or 3 months (with module fitted) back-up without mains power
<b>Alarm Sounder</b>	Piezoelectric Horn
<b>Alarm Sound Level</b>	85dB(A) at 3 meters (min)
<b>Memory Feature</b>	Indicates that the Alarm has previously detected fire
<b>Self Test</b>	Sensors, batteries and electronics are automatically tested periodically
<b>Test/Hush Button</b>	Checks sensors, electronics, interconnection and sounder. If the unit is in alarm when pressed, it silences the alarm for 10min
<b>Visual indicators</b>	Green LED – Power supply Yellow LED – Fault, EOL Red LED – Memory or alarm (if coincides with horn sounding)
<b>AudioLINK</b>	Enabled
<b>Operational Life</b>	10 years
<b>Interconnection</b>	Up to 12 units can be interconnected via a hardwired or wireless system (using optional Ei3000MRF SmartLINK module)



## Technical Specifications

<b>Fixings</b>	Supplied with Easi-fit anti-tamper mounting plate with integral terminal block and wiring cover, includes screws and wall plugs
<b>Operating Temperature</b>	Normal: 0°C to +40°C (Storage: 0°C to +40°C)*
<b>Humidity Range</b>	15% to 95% RH (non-condensing)
<b>Plastic Material</b>	UL94V-0 flame retardant rated
<b>Dimensions</b>	Ei3024 and Ei3014: Product: - Ø150mm x 66mm Package - 155mm x 155mm x 70mm
	Ei3016: Product: - Ø150mm x 63mm Package - 155mm x 155mm x 65mm
<b>Weight</b>	350g (including packaging)
<b>Warranty</b>	5 year (limited)
<b>Approvals</b>	KM522831
	KM83678
	EN14604:2005+AC 2008 BS5446-2:2003

\* Temperature and Humidity conditions are for normal operation and storage. Units will function outside these ranges as required by the specific product Standards. Extended exposure to conditions outside these ranges can reduce product life. For advice on prolonged operation outside these ranges consult the manufacturer.

# 2

## Installation

## 2.1 Important Safety Instructions



**Mains operated Alarms** should be installed and interconnected by a qualified electrician in accordance with the local appropriate Regulations for Electrical Installations. Failure to install this Alarm correctly may expose the user to shock or fire hazards and damage the product.

The Alarm is designed to be permanently mounted, using its own built-in terminal block to connect it to the mains. The mounting plate can be screwed directly to the ceiling. Alternatively, it can be screwed to a standard junction box (BS 4662 single gang accessory box). It requires a typical current of 3mA. The Alarm must not be exposed to dripping or splashing. There are important markings on the underside of the Alarm.



Alternative Energy Sources - (Wind, Solar, UPS etc.)

This product is designed to be connected to a Pure or True Sine Wave 230V AC supply. If connecting to a power source that utilises an inverter, e.g. PV solar panel, the Total Harmonic Distortion (THD) must be less than 5%. If in doubt please check with the manufacturer of the inverter. This also applies to battery powered UPS (Uninterruptible Power Supply) inverters.



**Light Dimmer Circuits** - The Alarms must not be powered from a light dimmer circuit.



**Do not install Alarms in new or renovated buildings until all work is completed.**



The Alarm must **not** be connected when the house wiring insulation is being checked with high voltages. i.e. Do **not** use a high voltage insulation tester on the Alarm.



The Alarm must be continuously powered 24 hours a day so it is important that it is not on a circuit that can be turned off by a switch.



**(UK)** BS 5839-6: 2013 gives the following recommendations regarding the mains supply to be used in a Grade D system. The power supply for the Alarms should be derived from the public electricity supply to the dwelling. The mains supply to the Alarms should take the form of either: (a) an independent circuit at the dwelling's main distribution board, in which case no other electrical equipment should be connected to this circuit (other than a dedicated monitoring device installed to indicate failure of the mains supply to the Alarms); or (b) a separately electrically protected, regularly used local lighting circuit. Alarms should be connected on a single final circuit, unless the means of interconnection is by radio signals (e.g. RadioLINK). (See BS 5839-6: 2013 for further information)

**(IRE)** Please refer to ET101: 2008: National Rules for Electrical Installations

## 2.2 Where to locate the Alarm

The advice here follows the guidance in British Standard BS 5839-Part 6:2013 and IS 3218:2013 in general (for further information refer to the relevant standards).

The main reason for fitting Smoke/Heat/Multi-Sensor Alarms in dwellings is to ensure that when there is a fire, sufficient early warning is given so that everybody can escape safely. This means that the fire Alarms should ideally be located near all potential sources of fires and that the alarm should be heard throughout the house – particularly in the bedrooms.

It is also important that nuisance/false alarms are minimised to ensure the Alarms are not disabled or ignored.

A single Smoke Alarm will give some protection if it is properly installed, but most homes will require two or more to ensure that a reliable early warning is given. For recommended protection you should put individual Smoke Alarms in all rooms where fire is most likely to break out (apart from the kitchen and bathroom).

BS 5839-Part 6:2013 and IS 3218:2013 give guidance on:

- how many Alarms to install
- what type of Alarm to use
- where to position Alarms

The above points will depend on the type of dwelling to be protected and the level of fire risk.

### **Fire Risk Assessment**

The 'Grade' and 'Category' of system that should be installed depends on the fire risk. It is therefore recommended that a Fire Risk Assessment is undertaken. The Risk Assessment would be based on a combination of probabilities:

- fire occurring
- injury or death to occupant
- system operating correctly with a fire
- early detection and warning to occupants in the event of a fire.

The greater the risks, the more comprehensive and reliable systems needs to be.

LD (Life protection in Dwellings) Systems define the level of fire protection required for households, depending on the fire risk and regulations. Ei Electronics recommends that an LD1 system be installed for optimum protection.

Please see following pages for detailed information.

## UK Requirements (BS 5839-6:2013)

### LD1 OPTIMUM PROTECTION

for dwellings where occupants may be at high risk (e.g. elderly)

**Optimum Protection LD1:** As LD2, but in addition Smoke or Heat Alarms should be located in all rooms and other areas of the dwelling.  
(apart from toilets or bathroom)  
*Interconnect all Alarms*

### LD2 BASIC PROTECTION

for new or materially altered dwellings or existing dwellings with poor structural fire precautions

**Basic Protection LD2:** Smoke or Heat Alarms in all rooms or areas that present a high fire risk to occupants.  
(apart from toilets or bathroom)  
*Interconnect all Alarms*

### LD3 MINIMUM PROTECTION

**Minimum Protection LD3:** Alarms in all hallways, stairways and circulation areas that form part of the escape routes from the dwelling.



**Multi-Sensor or Smoke Alarms** located:

- on each storey
- every 7.5 m of hallways and escape routes
- within 3m of all bedroom doors  
(apart from toilets & bathrooms ☒)



**Heat Alarms** located in:

- each Kitchen  
(Heat Alarms must be within 5.3m of potential fire sources)



**Multi-Sensor or Heat Alarms** located in:

- each Living room (i.e. most frequently used daytime room)

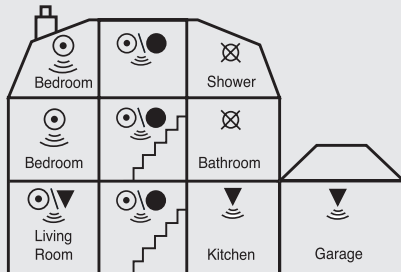

Multi Storey Dwelling LD1

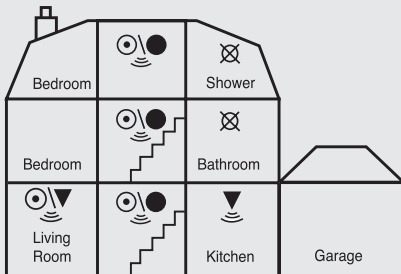

Multi Storey Dwelling LD2

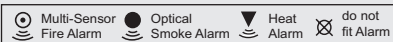

## ROI Requirements (IS 3218:2013)

### LD1 OPTIMUM PROTECTION

for dwellings where occupants may be at high risk (e.g. elderly)

**Optimum Protection LD1:** As LD2, but also including attics / lofts / other spaces in which a fire might start (apart from toilets or bathroom).

**Interconnect all Alarms**

### LD2 BASIC PROTECTION

for new or materially altered dwellings or existing dwellings with poor structural fire precautions

**Basic Protection LD2:** all circulation areas that form part of an escape route within the dwelling, and all high fire risk areas / rooms e.g. kitchen, living rooms, garages and all bedrooms (apart from toilets or bathroom).

**Interconnect all Alarms**



**Multi-Sensor or Smoke Alarms** located:

- on each storey
- every 7.5 m of hallways and escape routes
- within 3m of all bedroom doors (apart from toilets & bathrooms ☒)



**Heat Alarms** located in:

- each Kitchen (Heat Alarms must be within 5.3m of potential fire sources)



**Multi-Sensor or Heat Alarms** located in:

- each Living room (i.e. most frequently used daytime room)

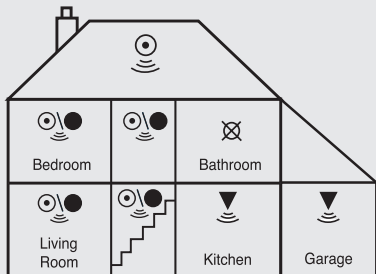

Multi Storey Dwelling LD1

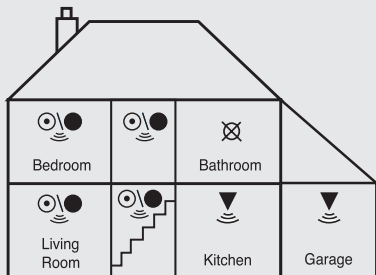

Multi Storey Dwelling LD2



Multi-Sensor Fire Alarm



Optical Smoke Alarm



Heat Alarm



do not fit Alarm

## 2.3 Which Alarm in what room?

Location	Ei3024 Multi-Sensor Fire Alarm	Ei3016 Optical Smoke Alarm	Ei3014 Heat Alarm (i)
Hall, Corridors, Escape routes	✓	✓	✗
Kitchens / Garages	✗	✗	✓ (iii)
Living Rooms	✓	✓	✓ (ii)
Bedrooms	✓	✓	✗
Shower / Bathrooms	✗	✗	✗

(i) A Heat Alarm should only be used in a room adjoining an escape route, in conjunction with Multi-Sensor Fire Alarms or Smoke Alarms on the escape routes. All the Alarms should be interconnected to ensure the early warning will be heard.

(ii) Some Fire authorities (concerned with the slow response of Heat Alarms) advise that Multi-Sensor Fire Alarms or Smoke Alarms should be fitted in living rooms. This is acceptable according to BS 5839-6 provided there are clearly not going to be problems with nuisance alarms. Fit Heat Alarms only if nuisance alarms are very likely and it is acceptable that a warning will only be given by the Heat Alarm when there is a very significant flaming fire in the room. If the door(s) and windows are not closed to contain the fire and heat, it is extremely unlikely that the Heat Alarm would respond before a Multi-Sensor Fire Alarm or Smoke Alarm sited outside in the corridor.

(iii) In enclosed kitchens with doors closed.



### **Improved Audibility**

The effectiveness of a Category LD2 (UK) system can be significantly enhanced if an additional Alarm (interconnected) is installed in the master bedroom. This will help ensure that a responsible person will quickly be alerted to a fire and can arrange for an orderly evacuation of children and other vulnerable occupants.

### **Grade D System**

The mains powered Ei3024 Multi Sensor Fire Alarm, Ei3016 Smoke Alarm and Ei3014 Heat Alarm with rechargeable battery back-up, covered by these instructions are suitable for the requirements for a Grade D System.

A Grade D system is needed for:

- new or materially altered dwellings up to three-storeys, with no floor over 200m<sup>2</sup> in area.
- Existing dwellings with poor structural fire precautions, up to three storeys, with no floor over 200m<sup>2</sup> in area.
- Houses in Multiple Occupation (HMOs) of one or two-storeys, with no floor over 200m<sup>2</sup> in area.
- Individual dwellings units of two or more rooms in HMOs.

Check that a Grade D system is adequate for the dwelling into which the system is being installed.

## 2.4 Where in the room?

*The locations must comply with applicable building regulations*

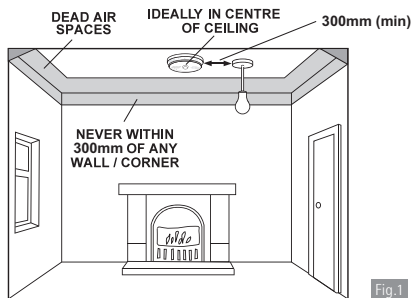

Fig.1

### Ceiling Mounting

Hot smoke rises and spreads out, so a central ceiling position is the preferred location. The air is "dead" and does not move in corners, therefore Alarms must be mounted away from corners. Fit the Alarm:

- At least 300mm away from walls (see Figure 1).
- At least 300mm from any light fitting or decorative object which might obstruct smoke / heat entering the Alarm.

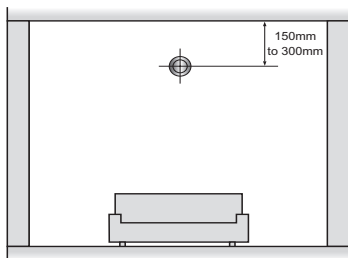

Fig.2

### Wall Mounting (Ei3016 only)

If ceiling mounting is impractical, **only** the Ei3016 Optical Smoke Alarm may be mounted on a wall, provided that:

- a) the top of the detection element is between 150mm and 300mm below the ceiling (see Figure 2);
- b) the bottom of the detection element is above the level of any door openings;

Wall mounting should only be considered where close spaced beams or similar obstructions may preclude ceiling mounting. It is considered to be the responsibility of the installer/client to determine if the presence of asbestos in the ceiling material would make ceiling mounting 'impractical'.

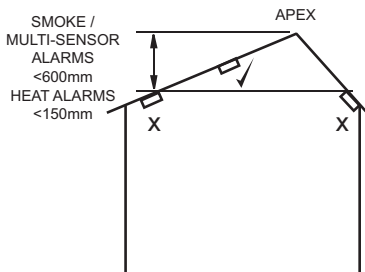

Fig.3

## Sloping Ceiling

With a sloping or peaked ceiling install a Smoke or Multi-Sensor Fire Alarm within 600mm of the peak (measured vertically) and a Heat Alarm within 150mm. If the height of the peak is less than 600mm in the case of Smoke or Multi-Sensor Fire Alarms or 150mm in the case of Heat Alarms, it is regarded as being flat. (see Figure 3).

## 2.5 Locations to avoid

### **DON'T place Smoke, Heat or Multi-Sensor Fire Alarms in any of the following areas:**

- Bathrooms, shower rooms or other rooms where the Alarm may be triggered by steam, condensation.
- Places where the normal temperature can exceed 40°C or be below 4°C (e.g. furnace rooms, directly above ovens or kettles etc.) as the heat/steam could cause nuisance alarms.
- Near a decorative object, door, light fitting, window moulding etc., that may prevent heat or smoke from entering the Alarm.
- Surfaces that are normally warmer or colder than the rest of the room (e.g. attic hatches). Temperature differences might stop heat or smoke from reaching the Alarm.

- Next to or directly above heaters or air conditioning vents, windows, wall vents etc. where air draughts can change the direction of airflow and cause rapid temperature fluctuations.
  - In very high or awkward areas (e.g. over stairwells) where it may be difficult to reach the Alarm (for testing, hushing etc.).
  - Locate away from very dusty or dirty areas as dust build-up on the optical smoke sensor can impair performance. It can block the insect screen mesh and prevent smoke from entering the sensor. Dust build up can also increase the response time of the heat sensor.
  - Locate the Alarm at least 1m from dimmer controlled lights and wiring as some dimmers can cause interference.
  - Locate the Alarm at least 1.5m and route wiring at least 1m away from fluorescent light fittings as electrical "noise" and/or flickering may affect the Alarm. Do not wire into the same circuit as fluorescent lights or dimmers.
  - Do not locate in insect infested areas. Small insects getting into the optical smoke sensor can cause intermittent false alarms. Insects and contamination on the heat sensor can increase its response time.
  - Do not locate in a damp or humid area.
- Do not locate Heat Alarms directly above a sink or cooker – Keep at least 1 m horizontal distance between these items and the Alarm.

## 2.6 Mounting and wiring

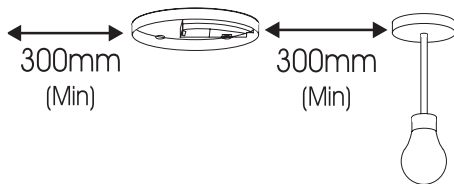

1. Select a location complying with the advice in previous sections.

2. Disconnect the AC mains supply from the circuit that is going to be used.

3. Lift off the wiring cover as shown in Figure 4.

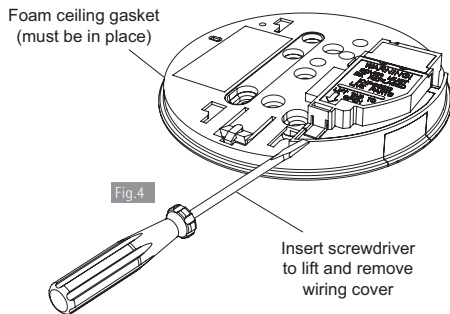

The wiring must be connected to the terminal block on the mounting plate as follows:

**L: Live** - connect to the house wires coloured brown or marked L.

**N: Neutral** - connect to the house wires coloured blue or marked N.

**IC: Interconnect** - see figures 5 and 6 and further information in Section 2.7.

**Note:** *Wiring must be installed in compliance with local regulations.*

**Warning:** Mixing (or leaving unattached) the Live and Neutral connections when interconnecting Alarms may damage all the Alarms - ensure that the same colour wires are used throughout the premises for Live, Neutral and Interconnect wires.

We strongly recommend that you check for the following **before connecting the Alarm:**

- check for Live and Neutral using a two probe tester.
- check for Live using a neon tester.
- check that the Interconnect wire is NOT connected to Live, Neutral or Earth. **Do not use an Earth wire for the Interconnect line.**

**Note:** The Alarm does not need to be earthed. However the terminal marked  is provided for the convenience of the installer so that any copper Earth wire or cable coloured green and yellow, can be safely terminated.

To interconnect Alarms connect all the IC terminals together as shown in Figure 9 (see **Interconnecting Alarms** section).

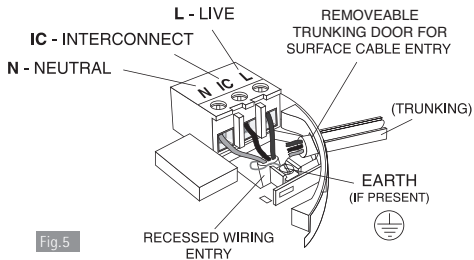

Fig.5

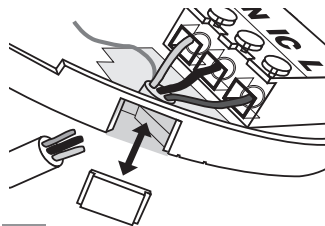

Fig.6

**4.** If the mains wires are recessed, bring the wires through the rear hole in the mounting plate as shown in Figure 5.

If the mains wires are being brought along the surface:

(a) position the mounting plate so the cable trunking is as shown in Figure 5.

(b) the mounting plate has a removable section, take it out to interface directly with 25mm trunking as shown in Figure 6. If interfacing to 16mm trunking carefully cut around the marked section, leaving the top intact and replace the section. (If you are not using surface wiring, the removable section must be left in place for electrical safety reasons).

There are two other positions which are also suitable for the surface wiring to enter (and exit) the Alarm, one next to the removable section and another directly opposite.

**5.** Carefully align the mounting plate and screw into place. Connect the wires to the terminal block. With recessed wiring, ensure the rear gasket seals around the edge of the hole in the ceiling or wall. This is to prevent air draughts affecting the smoke/heat entering the Alarm. If the hole is too large or the Alarm does not seal it, it should be sealed with silicone rubber or equivalent.

6. Replace the wiring cover and carefully line up the Alarm on the base and slide on (see Figure 7).
7. Connect the mains power to the Alarm circuit. Check the green light on the front of the Alarm is on.
8. Press and hold the test/hush button for 10 seconds (see Figure 8). The horn will sound. Check that any interconnected Alarms also sound within this period. The test button sounds the local horn and on release this horn stops immediately, and all the interconnected Alarms can then be heard in the distance as they will continue to sound for a further 3 seconds.
9. Attach the 'fuse board label' provided on or near the distribution board and write in date installed and the number of Alarms on the circuit.
10. Ensure the Alarm operates correctly - see **TESTING and MAINTAINING YOUR ALARM** section.

Fig.7

### Slide on the Alarm

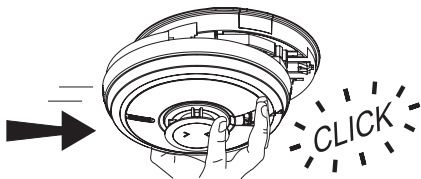
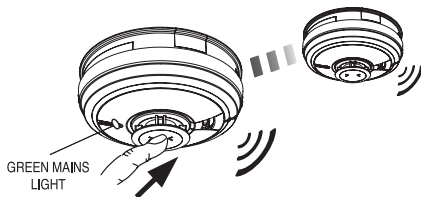

Fig.8

### Test Alarms





## 2.7 Interconnecting Alarms

With interconnected Alarms, when one device detects Fire all detectors will alarm. All horns will sound but only Alarms detecting the emergency event will be flashing their red LED alarm indicator.

**Heat Alarms** should **always be interconnected** to Smoke or Multi-Sensor Fire Alarms to ensure early warning.

**Note:** A maximum of 12 Fire / Smoke / Heat / CO Alarms and accessory devices can be interconnected in an Ei Electronics Alarm system. (Any Ei3000 series Alarm can also be interconnected to an Ei2110e, Ei160e and Ei140RC Series).

If you wish to connect more than 12 alarms, contact your local helpline.



**WARNING:** Do not connect these Alarms to any other type of Ei Alarm (apart from those listed above) or to any other model produced by another manufacturer. Doing so may damage the Alarms and could result in a shock or fire hazard.

Systems using more than 3 or 4 Alarms must be very carefully planned to ensure nuisance alarms are not excessive. e.g. from cooking fumes or steam. The following is suggested:

- In an RF system an Ei Electronics Control Switch (Ei450) should be incorporated and be readily accessible to all occupants so that the source of an alarm can be quickly identified. This is especially important when both Fire and CO Alarms are used in the same system as the occupant will need to open all windows and doors if it is a CO incident but do the opposite to slow down a fire.
- All Alarms must be cleaned and maintained regularly.
- A qualified person must be on call to quickly remove any nuisance Alarms (i.e. Alarm with red LED alarm indicator flashing rapidly) which are causing all the other Alarms to sound.

Make electrical connections as shown in Figure 9.

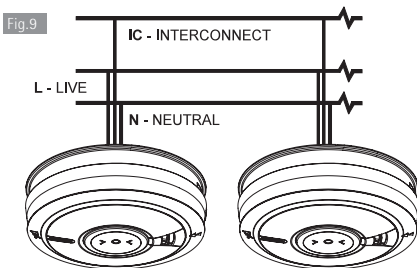

Wiring must be installed in compliance with local regulations.

In the UK and Ireland it is recommended that the following coloured cores are used (for example with triple flat 6243YH cable).

**230V supply** : Brown

**Neutral** : sleeved blue at terminations

**Interconnect** : Black

In the other countries consult the local regulations as they maybe different from the UK regulations.

The interconnect wire (minimum 0.75mm<sup>2</sup> cable) must be treated as if it was Live. It should be insulated and sheathed.

A maximum of 250 metres of wire can be used (maximum resistance between detectors 50 Ohms). Alarms should be interconnected only within the confines of a single family living unit. If they are connected between different units, there may be excessive nuisance alarms. Everybody may not be aware that they are being tested or that it is a nuisance alarm caused by cooking etc.

The Alarm can also be RF interconnected to other RF Alarms and devices by installing an Ei3000MRF SmartLINK Module. See the User manual for the Ei3000MRF for further details on RF interconnection. It is also equipped to work in a hybrid system (combination of hard-wired and RF interconnected Alarms and devices).

**Please note** in a hybrid system containing CO / Heat / Fire / Smoke Alarms we recommend using an Ei3000 series Alarm as the hybrid link to the RF section of the system.  
Ensure the Alarms operate correctly - see **TESTING YOUR ALARM** in the user section.

## 2.8 Removing the Alarm

**\* Disconnect mains before removal \***

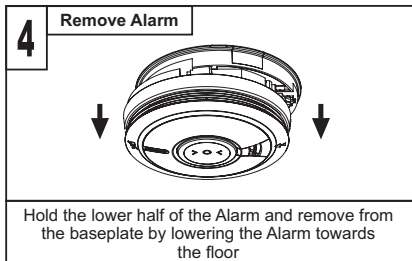
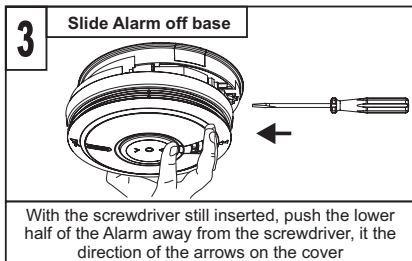
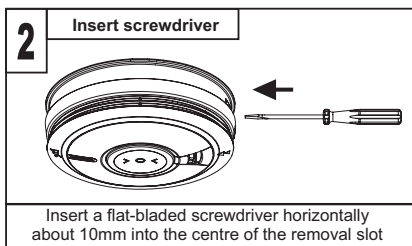
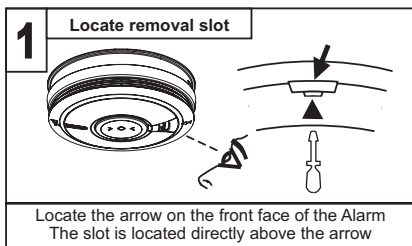

# User Guide

# 3

## Testing

### 3.1 Testing and maintaining your Alarm

Frequent testing of all your Alarms is a requirement to ensure they are functioning correctly. Guidelines and best practices for testing are as follows:

1. After the system is installed.
2. Once monthly thereafter.
3. After prolonged absence from the dwelling (e.g. after holiday period).
4. After repair or servicing of any of the systems elements or household electrical works.

#### Inspecting and Testing procedure

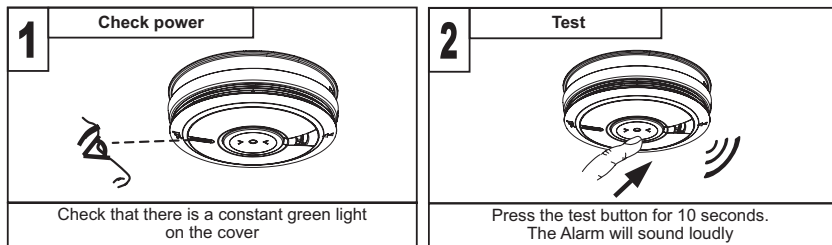

- (i) Check that the **green LED power indicator** is on continuously.
- (ii) Check also that there are no faults i.e. NO green, yellow or red LED flashing (if this is the case please see indicator summary table)

(iii) Press the **test button** for up to 10 seconds and ensure that the Alarm sounds. This tests the sensor, electronics and sounder are working. The Alarm will stop when the button is released. Pressing the test button simulates the effect of smoke and/or heat and therefore is the best way to ensure the Alarm is operating correctly. (Refer to indicator summary table if you see Red or Yellow LED flashes).

(iv) **Interconnected Alarms only** - Test the first unit by pressing the test button for 10 seconds. All the Alarms should sound within 10 seconds of the first horn sounding. After releasing the test button, the local horn will stop sounding immediately and the interconnected Alarms will be heard sounding in the distance for a further 3-4 seconds. This feature gives an audible verification that the interconnection is OK. Check all the other Alarms in the same way.

(v) Check the functioning of the mains battery back-up directly after installation and then at least yearly as follows:

- Turn off the mains power at the distribution board and check that the green indicator light is now flashing (1 flash every 48 seconds) to indicate the Alarm is on backup battery power.
- Press the Test/Hush button for up to 10 seconds and ensure the horn sounds loudly.
- Monitor the Alarm over a 3 minute period for any fault chirps and or yellow LED fault indicator flashes (Refer to "**Fault Modes**" table on what to do if this occurs)
- Turn the mains supply at the distribution board back on.

### **Switching off Mains for long periods**

If the premises are regularly being left without mains power for long periods the Alarms should be removed from their mounting plates and the Ei3000MRF modules (if fitted) should be removed to prevent the batteries becoming fully depleted. (This is sometimes done with holiday homes which are only occupied in the summer).

The Ei3000MRF modules (if required) must be re-fitted to the Alarms and the Alarms must be re-attached to the mounting plates when the premises are re-occupied. Ensure to match the original RF module back to the same Alarm head.

(Long term storage (over 1 year) can damage the batteries such that they will not recharge when the units are re-connected to the mains supply).

**WARNING: DO NOT TEST WITH FLAME**

This can set fire to the Alarm and damage the house. We also do not recommend testing with heat as the results can be misleading unless special apparatus is used.

### 3.2 Cleaning your Alarm

Clean your Alarm regularly. In dusty areas it may be necessary to clean the Alarm more frequently.

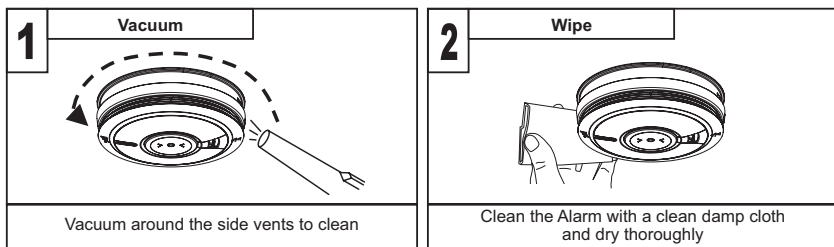

Use the narrow nozzle attachment of your vacuum cleaner to remove dust, insects and cobwebs from the sides and cover slots where the airflow enters. Clean the outside cover by occasionally wiping with a clean damp cloth then dry thoroughly with a lint free cloth. Do not use any cleaning agents, bleaches, detergents or polishes, including those in aerosol cans.

**WARNING: Do not paint your Alarm.**

Other than the cleaning described above, no other customer servicing of this product is required. Servicing or repairs, when needed, must be performed by the manufacturer.

All Alarms are prone to dust and insect ingress, which can cause false alarms or failure to alarm. In certain circumstances, even with regular cleaning, contamination can build up in the smoke sensing chamber causing the Alarm to sound or fail. Contamination is beyond our control, it is totally unpredictable and is considered normal wear and tear. For this reason, contamination is not covered by the guarantee.



# 4

What to do in  
case of alarm

(i). Check room doors for heat or smoke. Do not open a hot door. Use an alternate escape route. Close all doors behind you as you leave.



(ii). If smoke is heavy, crawl out, staying close to floor. Take short breaths, if possible, through a wet cloth or hold your breath. More people die from smoke inhalation than from flames.



(iii). Get out as fast as you can. Do not stop for packing. Have a prearranged meeting place outside for all family members. Check everybody is there.



(iv). Call the Fire Brigade immediately on a mobile phone or from a neighbour's house. Make sure to call the Brigade for all fires no matter how small - fires can suddenly spread. Also call the Brigade even if the alarm is automatically transmitted to a remote manned centre - the link may have failed.



(v). NEVER re-enter a burning house.

















# 5



## Troubleshooting and Indicator summary tables





<p><b>Your Alarm does not sound when you press the Test button</b></p>	<ul style="list-style-type: none"> <li>• Check the Alarm is secured correctly on the mounting plate.</li> <li>• Wait 15 seconds after connecting the power before button testing.</li> <li>• Hold button down firmly for at least 10 seconds.</li> <li>• If the horn does not sound, then your Alarm must be returned for repair or replacement - see <b>GETTING YOUR ALARM SERVICED</b> section</li> </ul>
<p><b>Your Alarm sounds for no apparent reason</b></p>	<ul style="list-style-type: none"> <li>• If, when the Alarm sounds, there is no sign of smoke, heat or noise to indicate that there is a fire, you should get your family into a safe place, before you start investigating.</li> </ul> <p>Check the house carefully in case there is a small fire smouldering somewhere.</p> <p>Check for smoke, fumes, steam, very hot air etc.</p> <ul style="list-style-type: none"> <li>• Locate the Alarm that sounds and has flashing red LED.</li> <li>• If you have thoroughly investigated and are sure that it is just a nuisance alarm, simply press the Test/Hush button briefly to silence the Alarm for 10 minutes. This will also silence any interconnected Alarms for the same period. When the Alarm is in 'Hush' mode the red LED will continue to flash while it detects the presence of smoke or heat.</li> </ul> <p>The Alarm will reset to normal functionality at the end of the 10 minute. If additional silenced time is required, simply push the Test/Hush Button again.</p> <ul style="list-style-type: none"> <li>• If you experience frequent nuisance/false alarms, it may be necessary to re-locate the Alarm away from the source of the fumes or if it continues to sound without smoke or heat being present and cleaning the Alarm does not solve the problem, it needs to be replaced</li> </ul>

<p><b>Interconnected Alarms do not all sound</b></p>	<ul style="list-style-type: none"> <li>• Hold test button for at least 10 seconds to ensure that the signal is transmitted to all the interconnected Alarms.</li> <li>• If this is not the case and you have a hardwired interconnection, we recommend you consult a qualified electrician.</li> <li>• If the Alarm is fitted with an RF module for wireless interconnection, check that all Alarms in the RadioLINK system are powered and are house-coded correctly. (see the Ei3000MRF SmartLINK module manual)</li> </ul>
<p><b>Pressing the Test/Hush button does not silence the Alarm</b></p>	<p>Always make sure that you are pressing the Test/Hush button on the Alarm that sounds with the red LED flashing.</p>
<p><b>Your Alarm chirps/beeps/ flashes</b></p>	<p>In standby mode, the Alarm does not sound, beep, chirp or flash. The only light on is the green power LED.</p> <p>The Alarm automatically monitors the battery, sensor and electronics periodically to ensure that all are satisfactory. If a fault has been found, the Alarm alerts the occupier to this via short chirps from its sounder and its yellow LED fault indicator flashes every 48 seconds. The Alarm will also indicate any faults when the test button is pressed.</p> <p>See indicator summary table on the next pages</p>

Normal mode					
Mode	Action	Green LED (power)	Yellow LED (fault)	Red LED (alarm)	Sound
Power up	Slide onto mounting plate	 x 1	 x 1	 x 1	—
Standby	—		—	—	—
Testing (monthly)	Press and hold test button	 *	—	—	
In alarm mode					
Detecting fire	—		—		
Activated via interconnect	—		—	—	
Pressing Silence Button on Alarm detecting fire	—		—		 x 10mins

\* With the test button held the green LED will flicker/pulse every second

 = LED on solid     = LED flashing

Memory mode			
Status	Action	Red LED (alarm)	Sound
0-24h	—	 every 48 sec x2	—
>24h +	Press and hold test button	 every 8 sec x2	
To erase the memory	Keep test button pressed for >20s		Sounds until test button is released

The Alarm memory is an important feature where even if the house is unoccupied during an alarm condition it warns the homeowner that the Alarm has previously detected Fire and been in alarm.

The memory feature also helps identify the unit which has previously triggered an entire alarm system, which can also be very helpful after the entire alarm system has gone into alarm and then stopped, for no obvious reason. Once the source alarm has been identified, appropriate action can be taken e.g. in the case of a fire alarm event in memory, investigate the cause of nuisance / false alarms by ensuring kitchen or bathroom doors are kept closed to prevent very hot air or steam from cookers / showers reaching the heat sensor on the Alarm, locate the Alarm further away from the source of steam or condensation, replace the Alarm if it is thought to be defective or remove the unit in the short term.



















The memory feature has two operation modes:

- memory indication for 24 hour period after alarm.
- memory recall on demand

**24-hour memory indicators:** For 24 hours after alarming, the red LED will flash twice every 48 seconds (approx)

**Memory recall on demand:** To review the memory status at any time, press and hold the test button, the red LED will flash twice to convey the alarm event in memory, if any.

**Reset Memory:** Hold down the test button for at least 20 seconds. Cover the horn with a cloth to muffle the alarm during this time. Clearing of the memory is indicated by a 1-second-long flash of the red LED. Please note that the alarm memory will also be reset if the Alarm is removed from its mounting plate.

Fault modes and Memory indicator					
What you hear / see				What it means	What to do
Green LED <sup>1</sup> (power)	Yellow LED <sup>2</sup> (fault)	Red LED (alarm)	Chirps		
 every 48 sec x1	—	—	—	AC mains off	Reconnect AC mains power
—	 every 48 sec x1	—		AC mains off Low battery backup	Reconnect AC mains power
	 every 48 sec x1	—		Low battery backup	Replace Alarm
	 every 48 sec x2	—	 x2	Sensor fault	Replace Alarm
	 every 48 sec x3	—	 x3	End of Life	Replace Alarm
	 every 8 sec x4	—	 x4	Max Dust Compensation has been reached	see Maximum Dust Compensation section
	Flashes as per fault type	—	—	Fault chirps have been silenced. Rate of the yellow LED flashing indicates fault type	If required chirping can be silenced again by pressing Silence button
	—	 when pressing Test button	—	There has been an alarm in your absence	Check Alarm memory section

**1** ON when AC mains power is switched on, flashes every 48s when on backup battery, Off when both AC mains and backup battery are off.

**2** If you are unsure of the amount of flashes of the Yellow LED you can at any time while a fault condition exists, press the Test button. The relevant number of flashes will then be 8s apart.

**Note:** Fault chirps can be silenced by pressing the Test/Hush button.



The Alarm can communicate its status and history through various Led flashes and chirps/beeps. However, a more comprehensive report of all such events is available through the AudioLINK download via the App.

## Low Battery Backup Fault

If the battery backup supply is depleted, the sounder will give one short chirp with one yellow LED fault indicator flash every 48 seconds. In this case check that the green LED power indicator is on continuously. If it is off, or flashing every 48 seconds, the Alarm is not receiving 230V AC mains power and is being powered by the battery backup. The chirp every 48 seconds indicates that the battery is depleted. The battery is not replaceable. Check fuses, circuit breakers and wiring to determine the cause of the interruption to the mains power. If in doubt, contact a qualified electrician. Once mains power is reinstated, the chirps should cease within 2 hours as the battery charges up. Fully charged, the battery will provide up to 4 months back-up without mains power. If the chirping persists for over 2 hours with the green light on, there may be some other problem with the Alarm. The Alarm must be returned for repair or replacement - see **GETTING YOUR ALARM SERVICED** section.

## Sensor Fault

The Alarm regularly checks the optical smoke sensor and/or thermistor heat sensor for correct operation. If the Alarm has found a fault with the sensor, it will give 2 short chirps with 2 yellow LED flashes every 48 seconds. In this case, the Alarm must be returned for repair or replacement - see **GETTING YOUR ALARM SERVICED** section

## End of Life

Once the Alarm passes its 10th year of installation, it will give 3 short chirps with 3 yellow LED flashes every 48 seconds to indicate it has reached its end of useful life.

The entire Alarm must be replaced (Also check the replace by date on the label on the side of the Alarm). Disconnect the mains first and replace the Alarm - see 'Removing the Alarm' section.

### **Maximum Dust Compensation (Ei3016 and Ei3024 only)**

The Alarm monitors the dust contamination build-up in the optical smoke chamber and then compensates for it, reducing the possibility of false alarms.

If however, the Alarm gives 4 short chirps with 4 yellow LED flashes when the test button is pressed, it indicates that the Alarm has reached the maximum dust compensation. When this occurs, the Alarm will continue to operate as normal, but there is an increased risk of false alarms caused by dust contamination.

If contamination has occurred quickly (e.g. due to dust from carpets being replaced) and the Alarms are sounding, the dust compensation may take some hours to operate. In this situation, remove the Alarm from the ceiling, leave it disconnected for 5 minutes, then reinstall the unit (the air must be clean i.e., dust and smoke free). The dust compensation will now operate quickly, within 60 seconds.

### **Temporarily Silencing the Fault chirps**

If the test / hush button is pressed on an Alarm that is giving fault chirps and yellow LED fault indicator flashes, the Alarm will be silenced (Fault Hush mode) for a period of 12 hours. However, the Alarm will sound / function as normal within that period should it detect Fire (except if the fault detected is a sensor fault). The yellow LED fault indicator will continue to flash as before to indicate the fault is still present. This is a useful feature should the fault occur at night as it keeps the disturbance at a time when people in the building are trying to sleep to a minimum. The fault chirps would return 12 hours later, which perhaps may be a more suitable time to address the fault issue with the Alarm. In case of low backup battery voltage and end of life fault chirps, this can be repeated as required. A sensor fault condition can only be hushed once.

# 6

## Important safeguards

## Limitations of Fire Alarms

Multi-Sensor Fire / Smoke / Heat Alarms can significantly help to reduce the risk of fire fatalities. However independent authorities have stated that these systems may be ineffective in some fire situations. There are a number of reasons for this:

- The Alarms will not work if the mains power supply is off or disconnected and the backup battery is depleted. Test regularly to ensure the power supply is functioning as required.
- The Alarms will not detect fire if sufficient heat/smoke does not reach the Alarms. Heat/smoke may be prevented from reaching the Alarm if the fire is too far away, for example, if the fire is on another floor, behind a closed door, in a chimney, in a wall cavity, or if the prevailing air drafts carry the heat/smoke away. Installing Heat Alarms and Smoke Alarms on both sides of closed doors and throughout the house or premises as recommended in this leaflet will very significantly improve the probability of early detection.
- The Alarms may not be heard. An Alarm may not wake a person who has taken drugs or alcohol.
- The Alarms may not detect every type of fire to give sufficient early warning.
- The Alarms don't last indefinitely. The manufacturer recommends regular monthly testing and replacement after, at most, 10 years, as a precaution.

When a fire system is installed, basic safety precautions should always be followed, including those listed below:

- Please read all instructions.
- Use the Testing of the Alarm as a means to familiarise your family with the alarm sound and to practice fire drills regularly with all family members. Rehearse emergency escape plans so everyone at home knows what to do in case the Alarm sounds. Further information can be obtained from your local fire prevention officer.
- To maintain sensitivity to Fire, do not paint or cover the Alarm in any manner and; do not allow cobwebs, dust or grease to accumulate.
- If the Alarm has been damaged in any way or does not function properly, do not attempt a repair. Return the Alarm – see Section 7 - '**SERVICE AND GUARANTEE**' section.
- This appliance is only intended for premises having a residential type environment.
- Fire Alarms are not a substitute for insurance. The supplier or manufacturer is not your insurer.
- Do not dispose of your Alarm in a fire.

# 7

## Service and Guarantee

## 7.1 Getting your Alarm serviced

If, within the guarantee period, your Alarm fails to work after you have carefully read all the instructions, checked the unit has been installed correctly, and is receiving AC power, then contact us.

If you are advised to return your Alarm, please ensure that the Alarm is placed in a padded box, not attached to the mounting plate (as the Alarm can give beeps or alarm if the Test/Hush button is pressed during shipping), with the proof of purchase and a note stating the nature of the fault.

## 7.2 Guarantee

Ei Electronics guarantees this Alarm for five years from the date of purchase against any defects that are due to faulty materials or workmanship. If this Alarm should become defective within the guarantee period, we shall at our discretion repair or replace the faulty unit.

This guarantee only applies to normal conditions of use and service, and does not include damage resulting from accident, neglect, misuse, unauthorised dismantling, or contamination howsoever caused. This guarantee excludes incidental and consequential damage.

This guarantee does not apply to any product that has been modified in any way by a third party or has been fitted with a third party element.

Do not interfere with the Alarm or attempt to tamper with it. This will invalidate the guarantee but more importantly may expose the user to shock or fire hazards.

This guarantee is in addition to your statutory rights as a consumer.

The crossed out wheelie bin symbol that is on your product indicates that this product should not be disposed of via the normal household waste stream. Proper disposal will prevent possible harm to the environment or to human health. When disposing of this product please separate it from other waste streams to ensure that it can be recycled in an environmentally sound manner. For more details on collection and proper disposal, please contact your local government office or the retailer where you purchased this product.







0086

Ei Electronics, Shannon, Co. Clare, Ireland

18

DoP No.18-0001

EN14604:2005 + AC:2008

Smoke Alarm Devices:

Ei3016, Ei3024

Fire Safety

Nominal activation conditions/ sensitivity,  
response delay (response time) and  
performance under fire condition

**Pass**

Vibration resistance

**Pass**

Operational reliability

**Pass**

Humidity resistance

**Pass**

Tolerance to voltage supply

**Pass**

Corrosion resistance

**Pass**

Response delay and temperature resistance

**Pass**

Electrical stability

**Pass**



Heat Alarm Devices:

Ei3014, Ei3024

The Declaration of Performance No. 17-0001 may be consulted at [www.eielectronics.com/compliance](http://www.eielectronics.com/compliance)



KM522831

KM83678

EN14604:2005+AC 2008

BS5446-2:2003





P/N B18660 Rev0  
© Ei Electronics 2018

**Aico Ltd.** Mile End Business Park,  
Maesbury Rd, Oswestry, Shropshire SY10 8NN, U.K.  
Tel: 01691 664100

**[www.aico.co.uk](http://www.aico.co.uk)**

**Ei Electronics.** Shannon, Co Clare, Ireland.  
Tel:+353 (0)61 471277

**[www.eielectronics.com](http://www.eielectronics.com)**